

### 1 Beginner Guide

- Attention!**
- (1) Please install the suitable camera first before power on the Gimbal.
  - (2) Please turn off the power when not in use.

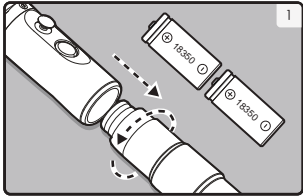

#### Insert The Batteries

Remove the power switch cap, insert two 18350 batteries into the handle.

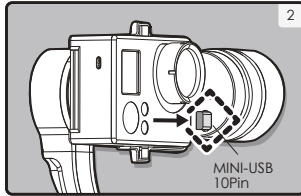

#### Mount the Camera

Mount the camera carefully to the mounting bracket and make sure the camera is firmly connected with the MINI-USB 10Pin.

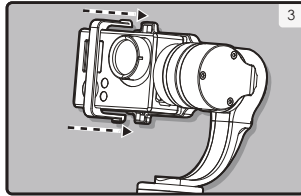

#### Assembly the clip

Press the clip at both ends of the clip, clip it as above picture.

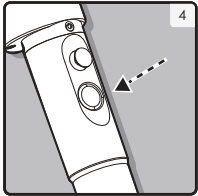

#### Power On / Off

**Power On:** Single tap the function button, the gimbal shall be powered on after 2 seconds.  
**Power Off:** Hold down the function button for 3 seconds to turn off the gimbal.

**Attention: Turn the gimbal on after ensuring the camera is secure.**

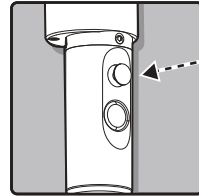

#### Joystick

You can control the direction by the joystick

### 2 Product Appearance Instructions

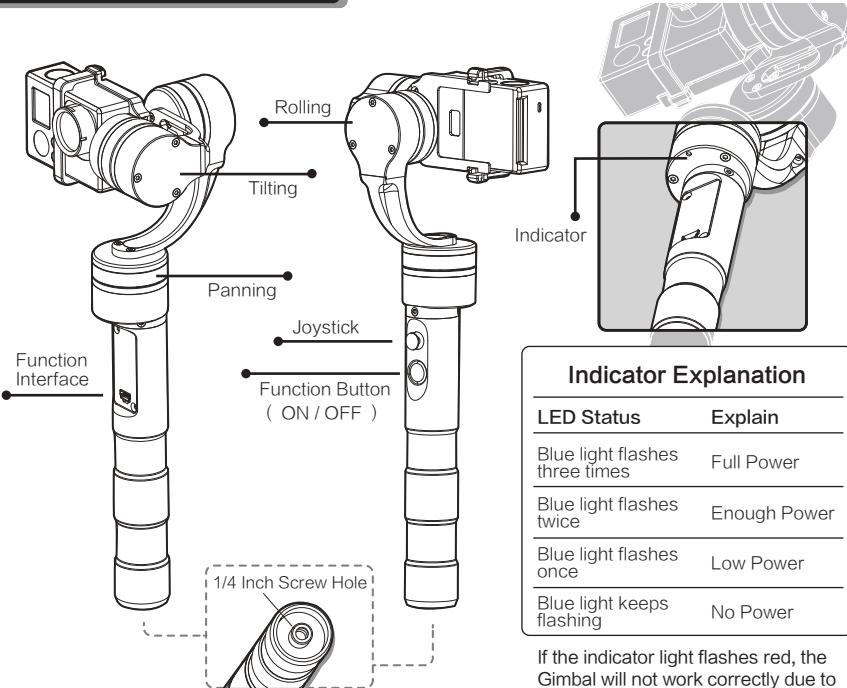
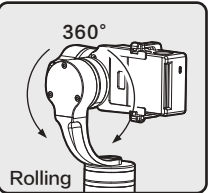
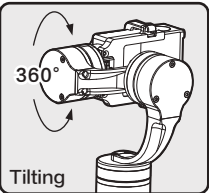
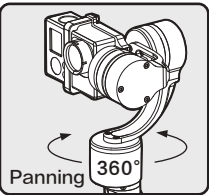

#### Indicator Explanation

LED Status	Explain
Blue light flashes three times	Full Power
Blue light flashes twice	Enough Power
Blue light flashes once	Low Power
Blue light keeps flashing	No Power

If the indicator light flashes red, the Gimbal will not work correctly due to an error.

### 3 Operation Instructions

Indicator Light Status	LED Status	Mode / Status
Single flash	Single flash	Panning mode
Double flashes	Double flashes	Panning and Tilting mode
Three flashes	Three flashes	Standby
Always on	Always on	Lock mode / Initialize the gimbal
Flash quickly	Flash quickly	Rolling angle adjustment / Initialization failure / Malfunction

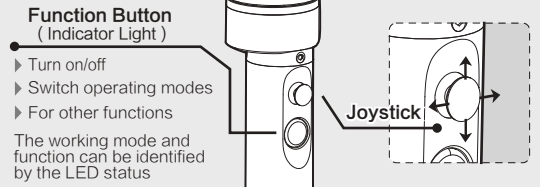

#### Working Mode Instructions

**Panning Mode** Camera is permitted to pan left or right. Vertical tilts or rolls are restricted.

**Panning and Tilting Mode** Camera is permitted to pan left or right and tilt up and down. Rolls are restricted.

**Lock Mode** Camera stays in its current orientation. All panning, tilting and rolls are restricted.

#### Other Function

**Inversion Mode** When in any working mode, press the function button for three times in succession, the Gimbal will enter into the inversion mode and switch to the Panning Mode automatically. Invert the Gimbal to capture more excited scenes easily by switching mode combination. When in inversion working condition press the function button for three times in succession to reset the Gimbal back to the original state.

**Reset** Reset the tilting axis of the gimbal to initial orientation and initial mode.

**Standby** In standby model, keep the gimbal in power-up state, the motor stops working, the indicator light flashes for three times, and single tap again to wake the gimbal.

#### Joystick Control

Joystick	Direction
Up	UP
Down	Down
Left	Left
Right	Right

#### Operating Instructions of Function Button

Operation	Function	Explanation
Single tap	Panning Mode / Lock Mode	Single tap to switch between panning mode and lock mode
Double tap	Panning and Tilting Mode	Under panning and tilting mode, single tap to switch to lock mode
Triple tap	Inversion Mode	It is possible to switch to other modes under inversion mode, triple tap again to exit inversion mode and reset
Quadruple tap	Reset	Reset the tilting axis of the gimbal to initial orientation and initial mode
Tap button for six times	Rolling angle adjustment	Please refer to "Gimbal Horizontal Angle Adjustment" for operations
Long press for 1 second	Standby	Single tap again to awake the gimbal, or triple tap to initialize the gimbal
Long press for 3 seconds	Power off	

### 4 Video Output

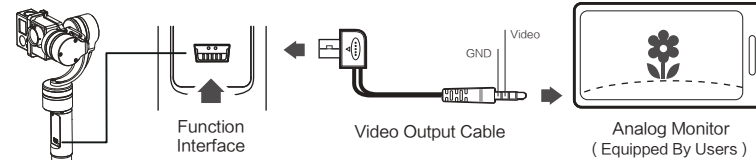

◀ When the gimbal and GoPro are powered on, connect the Analog Monitor to the function port with the Video Output Cable, to output the video to the Analog Monitor.

### 5 Read the GoPro SD card and Charge the GoPro

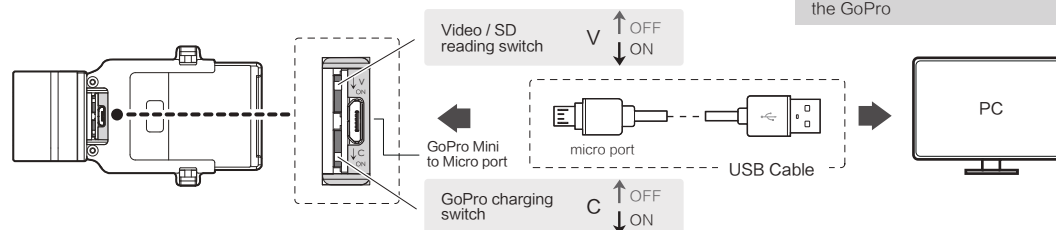

Read the GoPro SD card and charge the GoPro without dismount the GoPro

G4S 3-Axis handheld gimbal has a mini to micro port, It can connect the GoPro with a micro usb cable. You can read the GoPro SD card and Charge the GoPro without dismount the GoPro, and it works when the gimbal is powered off.

The GoPro charging switch and the SD card reading switch works independently, and it works when the gimbal is powered off. The default is off.

## 6 Firmware Upgrade

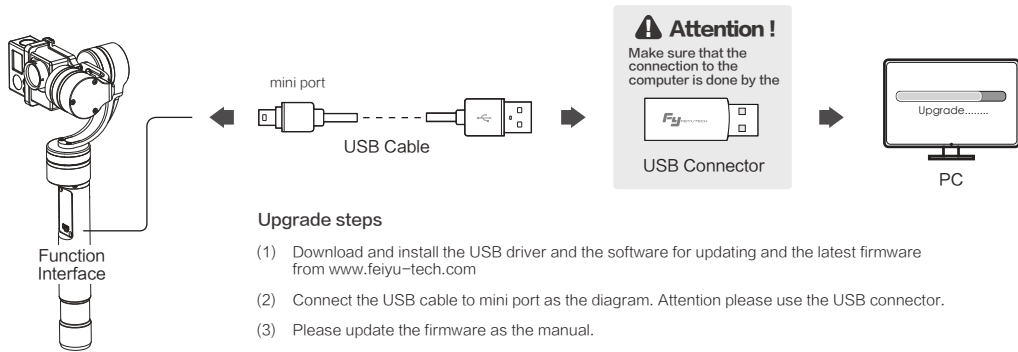

### Upgrade steps

- (1) Download and install the USB driver and the software for updating and the latest firmware from [www.feiyu-tech.com](http://www.feiyu-tech.com)
- (2) Connect the USB cable to mini port as the diagram. Attention please use the USB connector.
- (3) Please update the firmware as the manual.

## 7 Remote Control (Optional Item)

### Wireless Remote Control

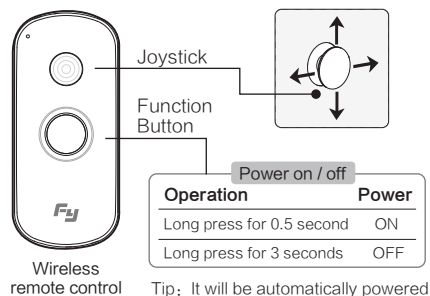

Tip: It will be automatically powered off to save battery if there is no operation within three minutes.

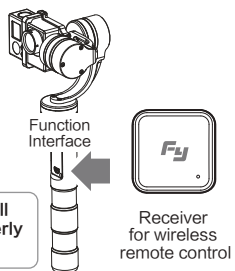

**! Please install the receiver properly before power on**

Receiver for wireless remote control

### Wired Remote Control

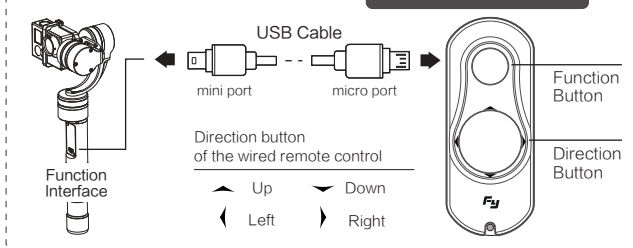

### Steps to connect wireless remote control:

- 1 Open the wireless remote control.
- 2 Install the receiver for wireless remote control: Insert the receiver for wireless remote control into the function port of gimbal .
- 3 Open the gimbal.
- 4 Use the wireless remote control to control the gimbal.

**Charging** Connect the Micro interface of wireless remote control with 5V charger (Not included) by USB cable.

**Remote Control Distance** 15 meters in an open environment.

**Match Code** Keep the gimbal powered on, restart the remote control and connect the receiver of RC to the gimbal, press the remote control function button for 7 times in 5 seconds, if the indicator on the RC flashes 5 times it means the receiver and the transmitter of RC match successfully, then customer can control the gimbal by the RC.

▲ RC needs to be match code whenever the following situations:

- (1) Connecting properly but still control in fail.
- (2) Change the receiver or wireless remote control

### Remote Control Operation Instructions

Operation	Explanation	Remark
Single Tap	Panning Mode / Lock Mode	Single tap to switch between panning mode and lock mode
Double Tap	Panning and Tilting Mode	Under panning and tilting mode, single tap to switch to lock mode
Triple Tap	Inversion Mode	It is possible to switch to other modes under inversion mode, triple tap again to exit inversion mode and reset
Quadruple Tap	Reset (Restore to the boot-up state)	Reset the tilting axis of the gimbal to initial orientation and initial mode
Tap Button Six Times	Calibration Using Remote Control	Please refer to "Gimbal Horizontal Angle Adjustment" for operations
Tap Button Seven Times	Match Code Mode <b>Wireless RC</b>	Match code when connecting properly but still control in fail or change the receiver/wireless remote control.
Long Press For 1 Second	Standby	Single tap again to awake the gimbal, or triple tap to initialize the gimbal
Long Press For 3 Second	Turn Off The Gimbal and RC <b>Wireless RC</b>	

Note: The joystick and function button will be disabled after connecting with the remote control.

## 8 Gimbal Horizontal Angle Adjustment

The horizontal angle needs to be adjusted whenever the following situations happen to the gimbal, user can adjust the horizontal angle by gimbal initialization and joystick.

- (1) The tilt angle is not leveled with the horizontal surface.
- (2) The roll angle is not parallel to the horizontal surface.
- (3) Under lock mode, the panning angle drifts.

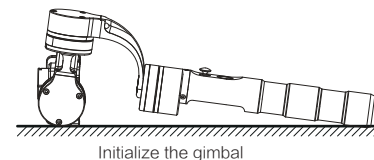

### Adjusting steps:

#### STEP 1 Initialize the gimbal

- (1) After powering the gimbal on, hold down the function button for one second to enter standby mode, and the LED indicator shall flash for three times;
- (2) Consecutively tap the function button for three times, LED indicator shall be always on, place the gimbal on a flat surface and keep it stationary;
- (3) When the initialization is completed, the LED indicator will flash for three times. Afterward pick up the gimbal and single tap to awake the gimbal.

▲ When the initialization failed, the LED indicator will flash quickly, repeat step (2) & (3) to reinitialize.

After finished the **STEP 1** , the rolling angle still not parallel to the horizontal surface, you can use the joystick to adjust the rolling angle according to **STEP 2** .

#### STEP 2 Rolling angle adjustment

Tap button for six times for roll angle adjustment, the tilt and roll angle restore to the horizontal status. Under the roll angle adjustment state, move the joystick to the left or to the right to adjust the roll angle, single tap again to save the setting and exit after adjusting.

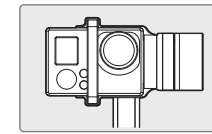

Note: Please adjust in this state

## 9 Specification

Vertical Tilting Angle	360°
Rolls Angle	360°
Horizontal Panning Angle	360°
Tilting Increments	2° /s ~ 75° /s
Panning Increments	3° /s ~ 150° /s

Working Voltage	6.0 V ~ 9 V
Overload Current Protection	800 mA
Usage Time	3 ~ 5 Hours
Adaption	GoPro HERO 4 / HERO3+ / HERO3
Weight	260 g (Without batteries & camera)

## 10 Standard And Optional Accessories

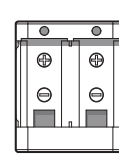

Charger  
Input: DC 5V  
Output: DC 4.2V

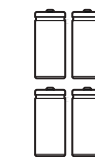

Rechargeable Battery  
Type: 18350



Video Output Cable



USB Connector

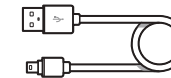

USB Cable

### How to Charging

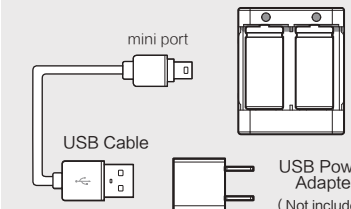

### DISCLAIMER

G4S 3-Axis Handheld Gimbal is a feature-rich camera stabilizer, yet lightweight and portable.

Prohibit any user for any illegal purpose. Users will be responsible for all behaviors of purchase and use products.

The Company assumes no liability for any risks related to or resulting from the debug and use of this product (including the direct, indirect or third-party losses).

For any unknown sources of using, we will not be at any services.

Feiyu Tech reserves the right to amend this manual and the terms and conditions of use the gimbal at any time.

### ATTENTION

Please assemble the gimbal in accordance to the diagram provided . Please upgrade the firmware and configuration settings with the provided USB data cable.

Please charge the battery with the provided battery charger. Please install the camera securely before powering on the gimbal.

**When the gimbal is not in use or placed on the table, please ensure it is powered off.**



Please visit the official website of Feiyu Tech to get related information: [www.feiyu-tech.com](http://www.feiyu-tech.com)  
Technical support: [service@feiyu-tech.com](mailto:service@feiyu-tech.com)

Everyone Can Make a Movie

